

NETZ 4in1

CELLULAR/LTE/MIMO/WIFI ANTENNA

Part #: 100-00142-01



Description

The NETZ 4 in 1 is a Cellular/LTE/MIMO/WIFI technology solution by Maxtena. The antenna features Cellular/LTE (698-960, 1710-2170, 2500-2700 MHz) and 2.4/5.0 GHz WIFI (2410-2490, 4920-5925 MHz) reception.

The 4 in 1 solution is ideal for high data throughput and streaming, video, industrial and IOT applications. The antennas advanced technology ensures constant reception and transmission. The under side of the antenna contains a foam adhesive for easy, reliable mounting. The antenna is waterproof and rated IP69K. It is available with an SMA, FAKRA or customer specified connector and cable length.

Features

- Screw Mount
- High Performance
- Rated IP67, IP69K and IK09
- Compact Size: 96 x 96 x 94 mm
- Custom Cable and Connector

Applications

- Fleet Management
- Commercial Transport
- HD Video Monitoring
- Buses, Train & Commercial Applications
- Smart Cities

Cable (LTE) Electrical Specifications

Parameter	Specification		
Standards	4GLTE/FirstNet/LPWA/CAT-X/CAT-Mx/CAT-NBx/NB-IoT/3G2G		
Band (MHz)	700/850/900	1700/1800/1900/2100	2600
Frequency (MHz)	698-960	1710-2170	2500-2700
Return Loss (dB)	-10.6	-16.3	-13.9
VSWR	2.0:1	1.4:1	1.5:1
Efficiency (%)	45.1	47.1	46.8
Peak Gain (dBi)	0.9	3.3	4.4
Average Gain (dB)	-3.5	-3.3	-3.3
Impedance (Ohm)	50		
Polarization	Linear		
Radiation Pattern	Omni-Directional		
Max Input Power (W)	25		
Connector Type	SMA-Male Standard (other connectors available)		
Cable Length	300 cm Standard (any cable length available)		
Cable Type	LL195 Standard (other cables available)		

Cable (WiFi) Electrical Specifications

Parameter	Specification	
Standards	WiFi, BT, ZigBee, WIFI	
Band (MHz)	2.4 GHz	5.0 GHz
Frequency (MHz)	2410-2490	4920-5925
Return Loss (dB)	-12.6	-14.4
VSWR	1.6:1	1.5:1
Efficiency (%)	44.9	35.9
Peak Gain (dBi)	4.8	3.0
Average Gain (dB)	-3.5	-4.5
Impedance (Ohm)	50	
Polarization	Linear	
Radiation Pattern	Omni-Directional	
Max Input Power (W)	25	
Connector Type	SMA-Male Standard (other connectors available)	
Cable Length	300 cm Standard (any cable length available)	
Cable Type	LL195 Standard (other cables available)	

Mechanical Specifications

Parameter	Specification
Mounting Type	Screw Mount
Dimensions (mm)	96 x 96 x 94
Radome Type	ASA UV Stable
Radome Color	Black or White
Antenna Base	ASA UV Stable
Operating Temperature (C)	-40 to +85
Storage Temperature (C)	-40to +85
Ingress Protection	IP67, IP69, IK09
Substance Compliance	RoHS

Radiation Performance

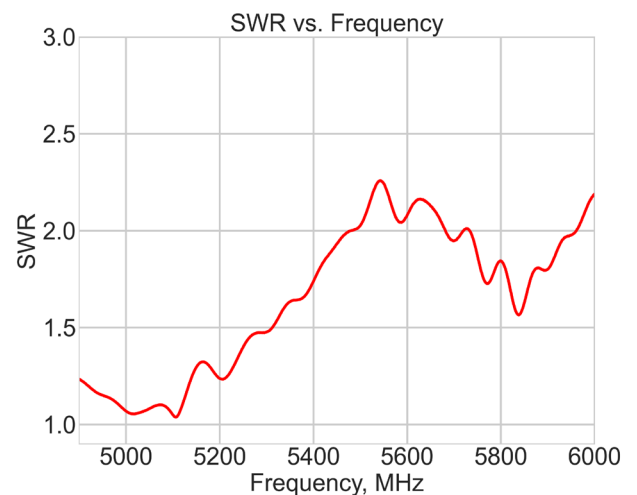
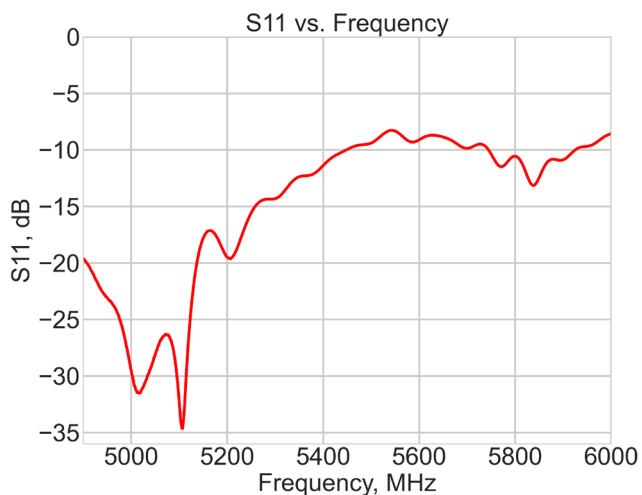

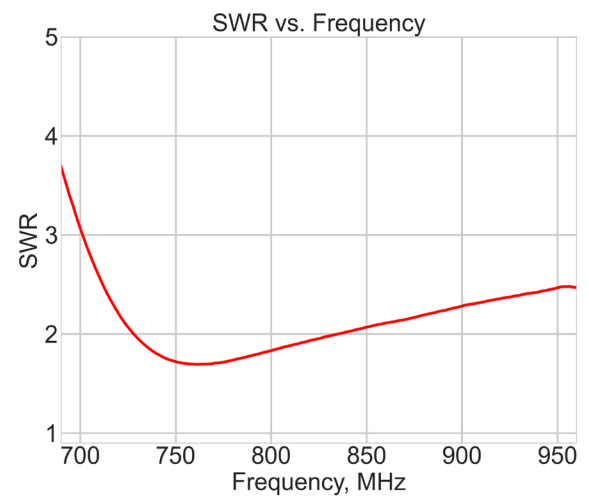
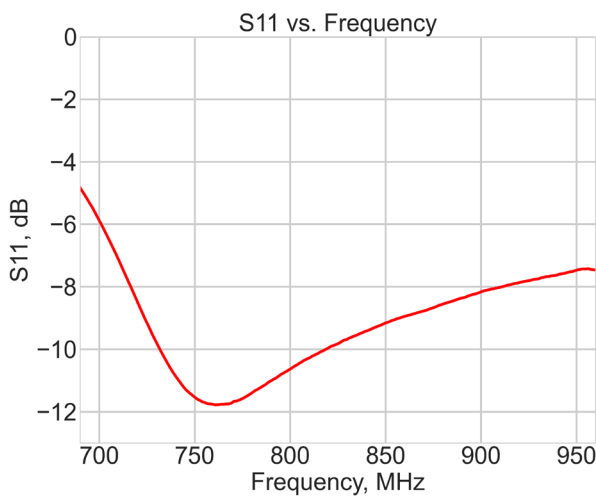
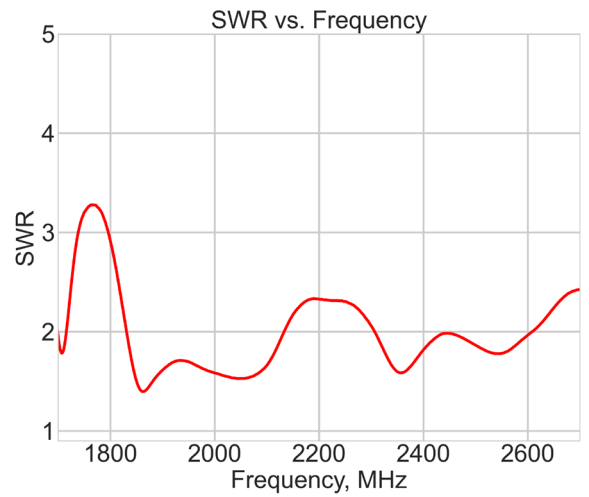
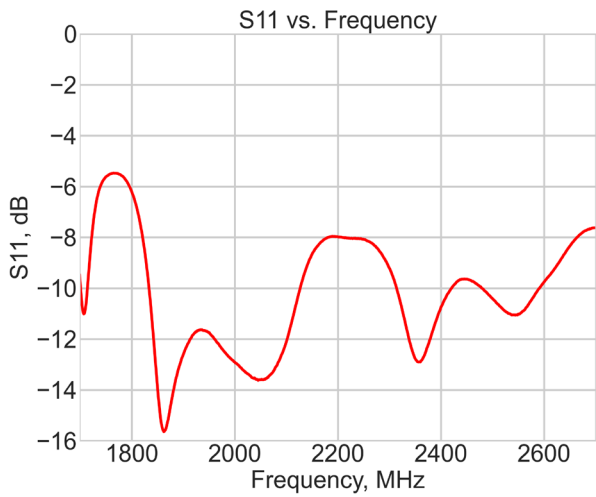
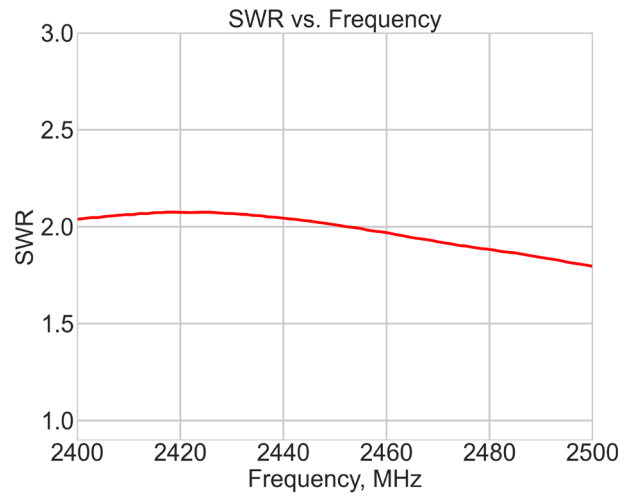
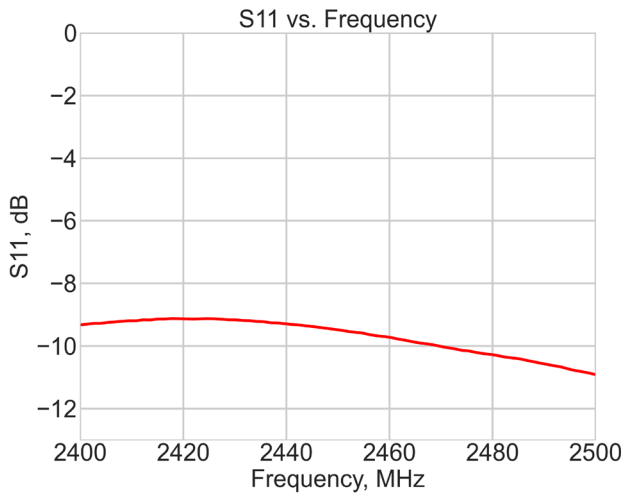

DRAWING REVISION HISTORY			
REV	DESCRIPTION	DATE	BY
A	INITIAL RELEASE	2020-11-06	QZ

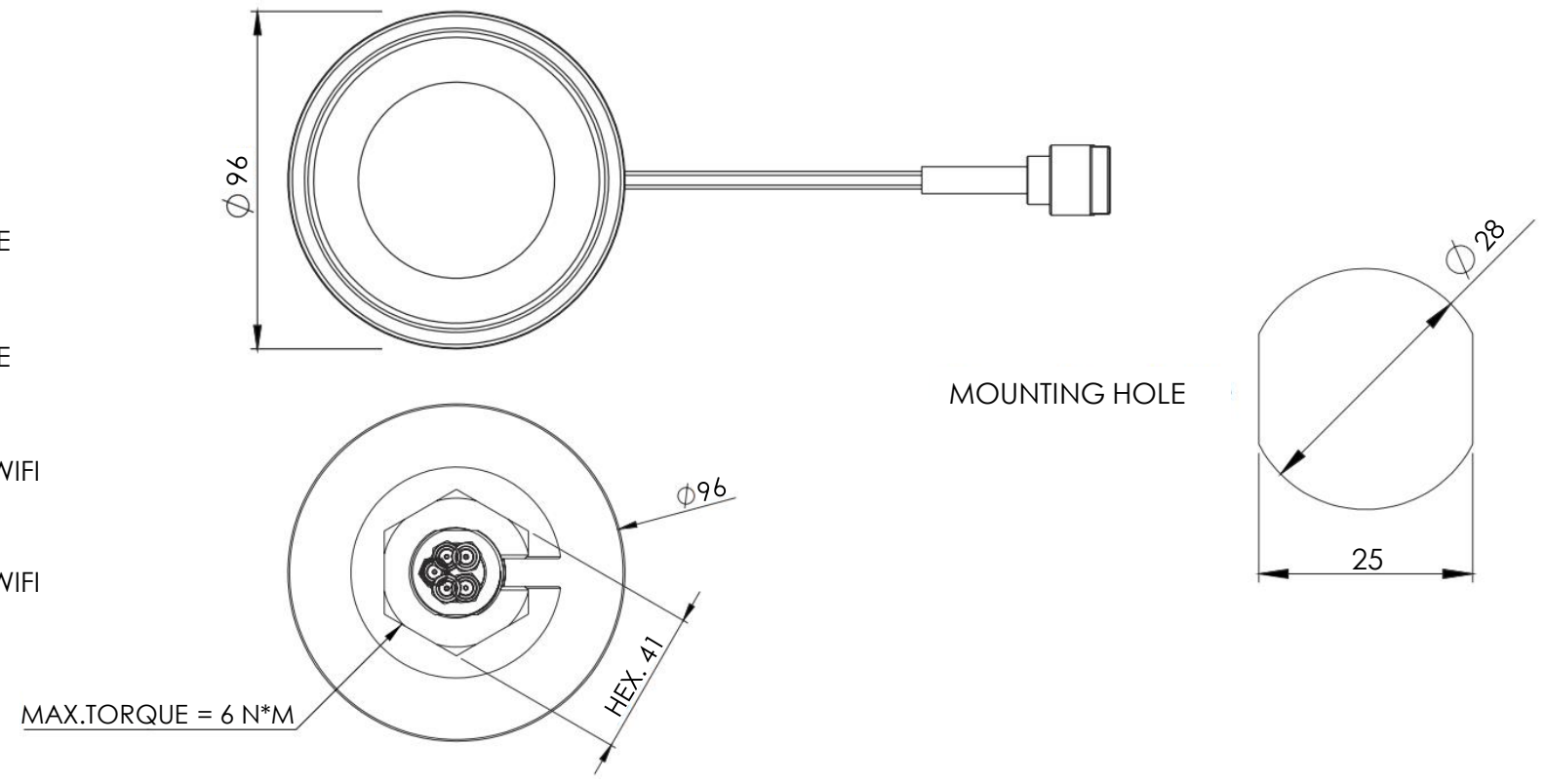
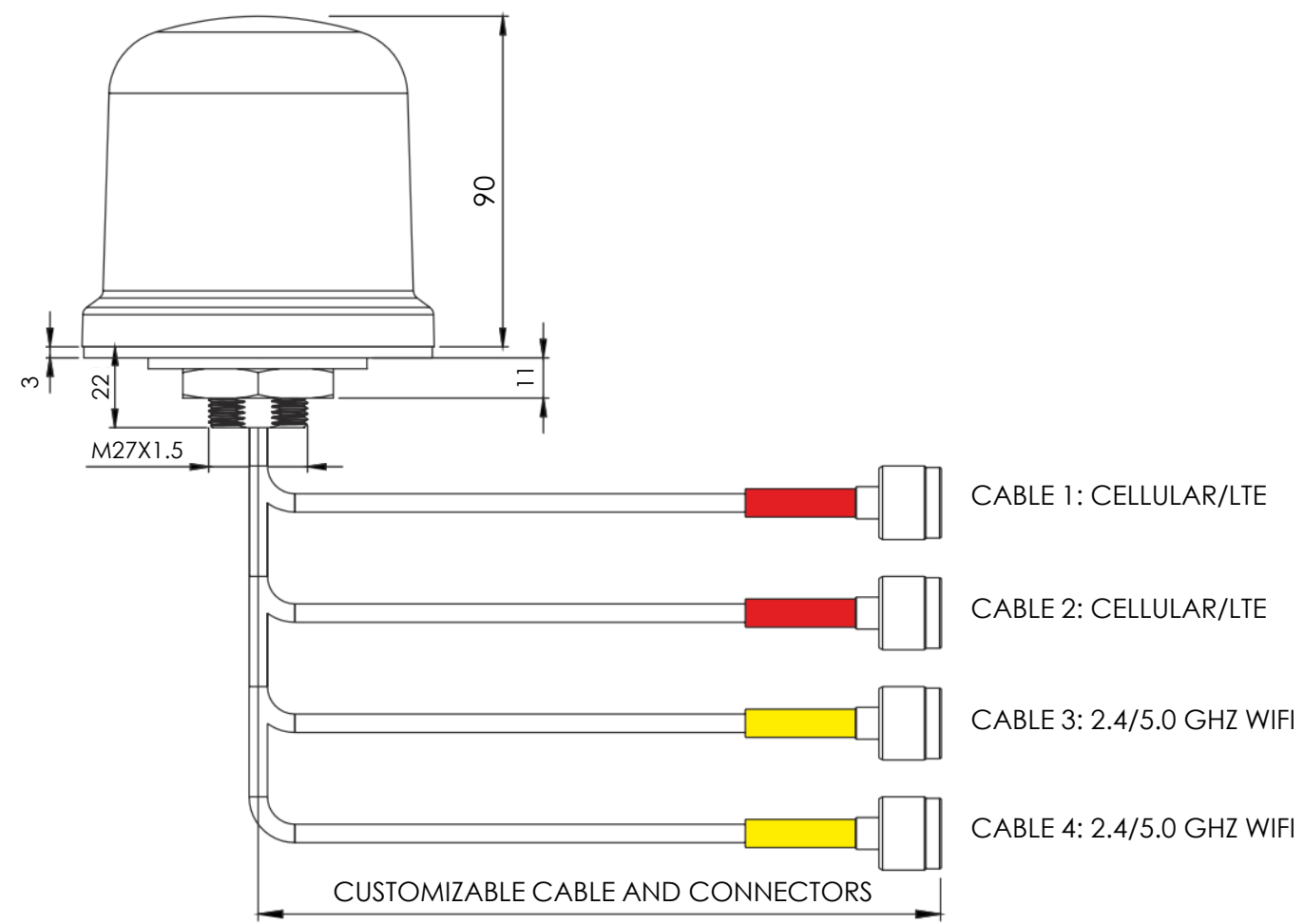

- NOTES:
1. GAIN: 3.3dBi
 2. INPUT POWER: 25W.
 3. IMPEDANCE: 50 Ω .
 4. CONNECTOR: SMA-MALE. OTHER CONNECTORS AVAILABLE.
 5. TEMPERATURE: -40 °C TO +85 °C.
 6. INGRESS PROTECTION: IP67, IP69, IK09.

ITEM 100-00141-01 REVISION HISTORY			
REV	DESCRIPTION	DATE	BY
A	INITIAL RELEASE	2020-11-06	QZ

UNLESS OTHERWISE SPECIFIED:	NAME	DATE
DIMENSIONS ARE IN MM	DRAWN	QZ 2020-11-06
TOLERANCES:	CHECKED	ZX 2020-11-10
FRACTIONAL \pm	ENG APPR.	NPC 2020-11-12
ANGULAR: MACH \pm 0.5° BEND \pm	MFG APPR.	
INTEGER \pm 2	Q.A.	
INTERPRET GEOMETRIC TOLERANCING PER:	CAD MAINTAINED. CHANGES SHALL BE INCORPORATED BY THE DESIGN ACTIVITY.	
THIRD ANGLE PROJECTION	DO NOT SCALE DRAWING	

MAXTENA, INC		
TITLE: 100-00142-01 NETZ 4 IN 1		
SIZE	DWG. NO.	REV
B	117-00363-01	A
CAGE CODE: 5KQH7	SCALE: NONE	SHEET 1 OF 1